

성토부2W가드레일(RS-11) SB4등급

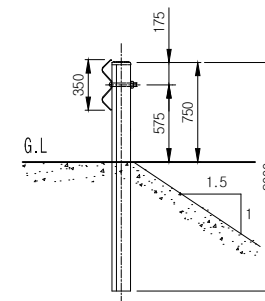

RAIL ELEVATION
SCALE: NONE

SIDE ELEVATION
SCALE: NONE

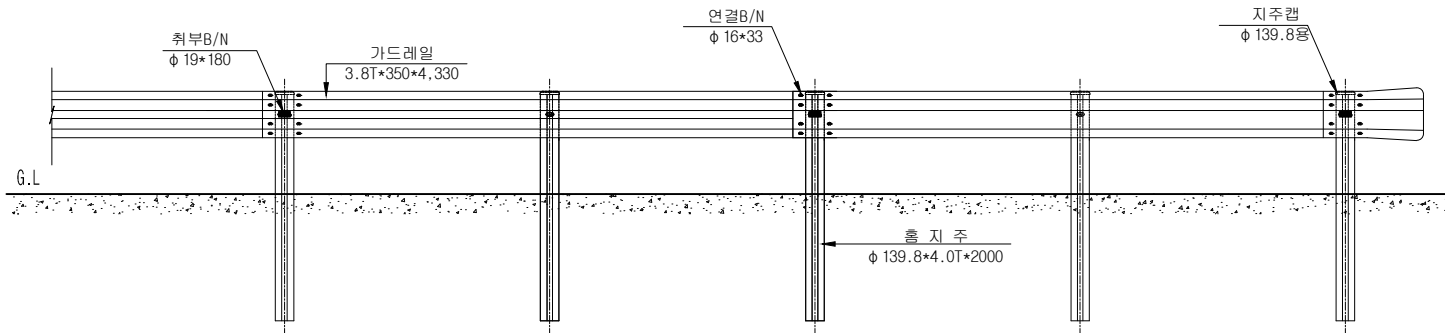
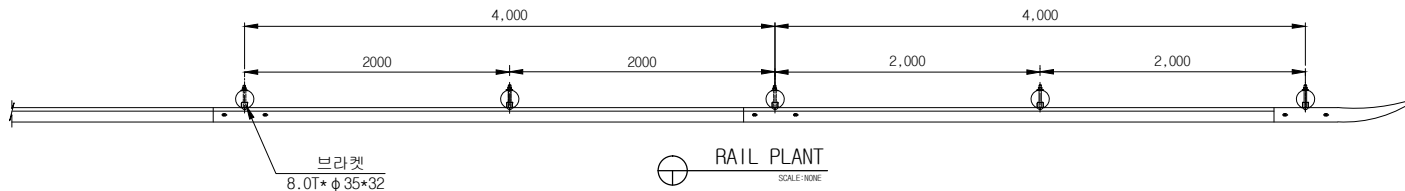
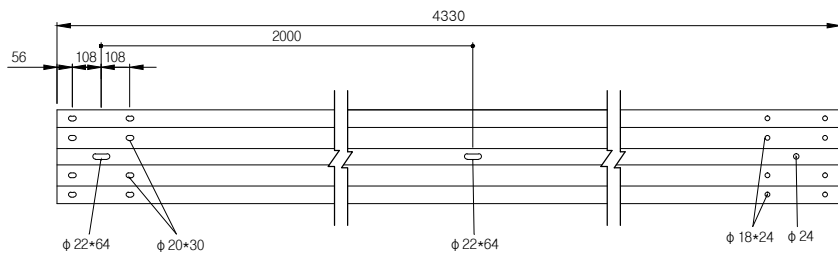

가드레일
SCALE: NONE

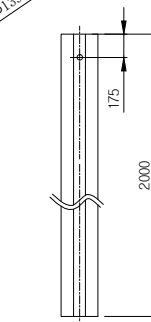
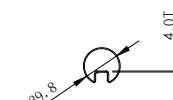

홀지주
SCALE: NONE

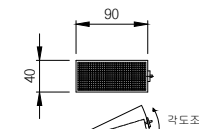

KD반사체
SCALE: NONE

표준구간(경간당)

(4M/1경간)

품명	규격	단위	수량	비고
가드레일	3.8T*350*4,330	매	1	SS400 KSD0503
홀지주	φ139.8*4.0T*2,000	본	2	SS400 KSD0503
지주캡	φ139.8용	EA	2	SS400 KSD0503
취부B/N	φ19*180	조	2	용융도금
연결B/N	φ16*33	조	8	용융도금
브라켓	8T*φ35*32	EA	2	
KD반사체	40*90	EA	1	

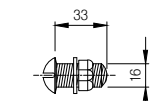

연결볼트
SCALE: NONE

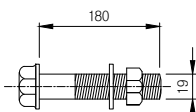

취부볼트
SCALE: NONE

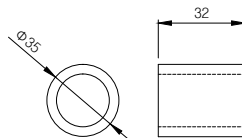

브라켓
SCALE: NONE

도면명	2W가드레일	등급	SB4	용도	성토부용	모델명	RS-11
공사명		날짜	2017.08.	축척	NON	도면번호	

(주)금동강건



KUMDONG

경남 밀양시 초동면 초동농공단지길 56
TEL:055)-391-1717, FAX:055)-391-4600
도로안전시설물 전문 생산업체