

2W표준 노측용 조립도SB4(RS-03)

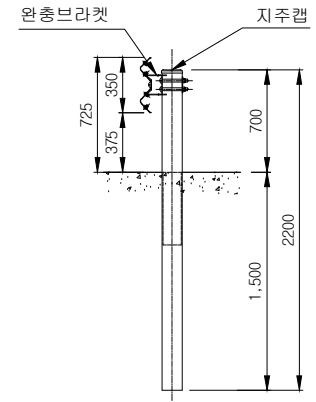

SIDE ELEVATION
SCALE: NONE

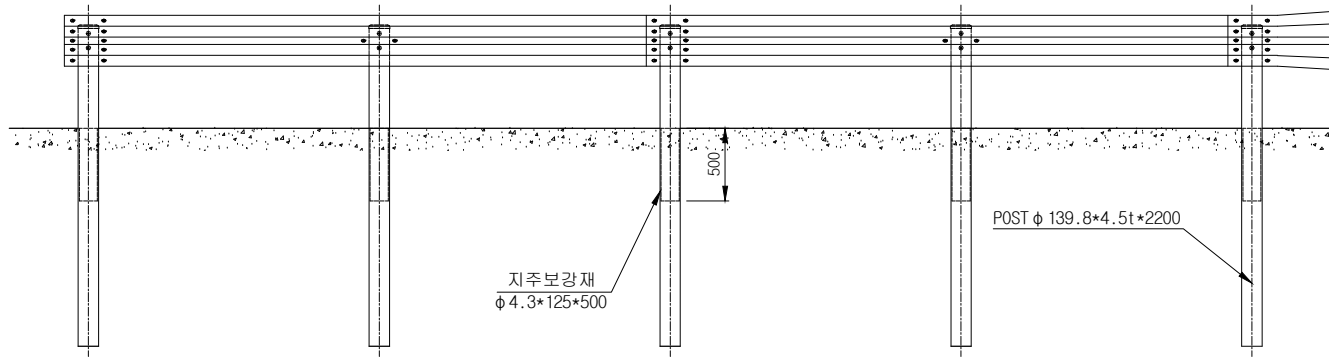
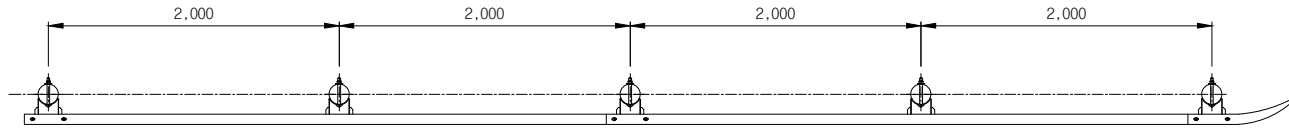
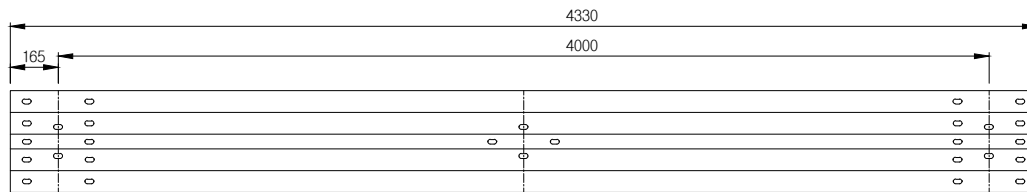

■자재리스트■

1장간 (2W)당 재료표

No	품명	규격	단위	수량	비고
1	GUARD RAIL	4330*350*4.0T	매	1	용융아연도금
2	PIPE POST	φ 139.8*4.0T*2200	본	2	용융아연도금
3	지주 CAP	φ 139.8용	EA	2	용융아연도금
4	완충브라켓	3.2*125*95	EA	2	용융아연도금
5	SETTING B/N	φ 19*180	조	4	용융아연도금
6	JOINTING B/N	φ 16*33	조	8	용융아연도금
7	SETTING B/N	φ 18*50	조	4	용융아연도금
8	지주보강재	φ 125*4.3T*500	본	2	용융아연도금

(주)제일산업외

도로 안전 부대시설 표준도

REV. No.

최종작성일

2006. 08.

도면
제 목

2W 표준 노측용 조립도(SB4)

도면
번호

2W 표준 노측용 각부분 상세도(RS-03)

조립도 상세도

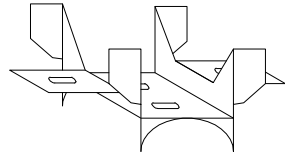
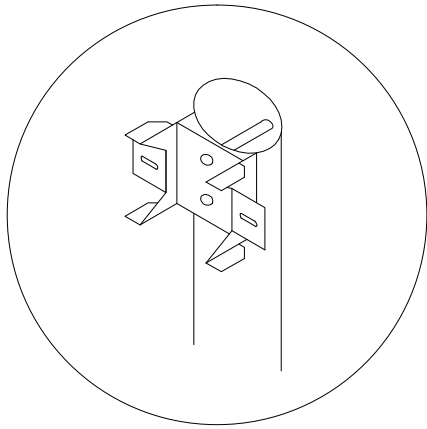

사시도

완충브라켓 상세도

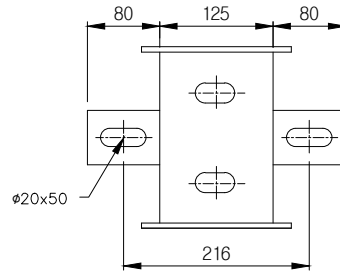

정면도

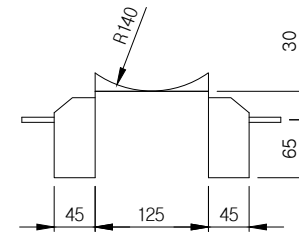

평면도

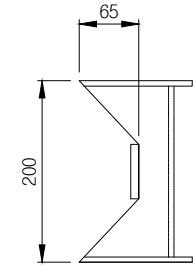

측면도

BOLT B/N상세도

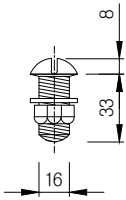

JOINTING B/N
($\phi 16 \times 33$)

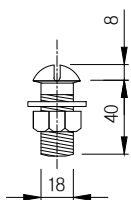

JOINTING B/N
($\phi 18 \times 50$)

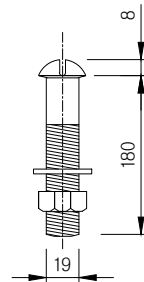

SETTING B/N
($\phi 19 \times 180$)

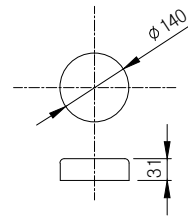

지주캡 상세도

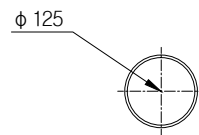

지주보강재상세도

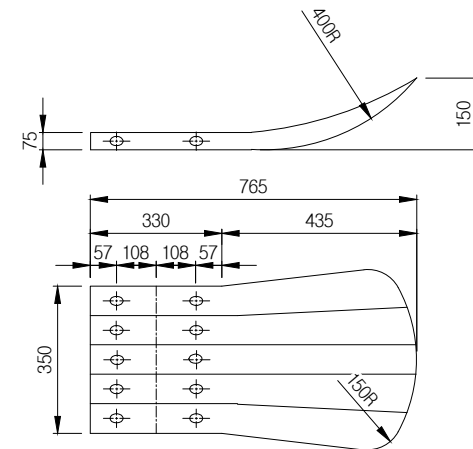
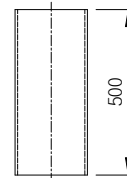

END Rail 상세도

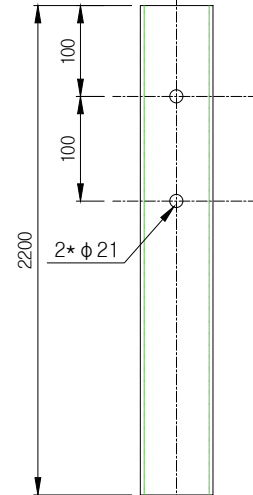
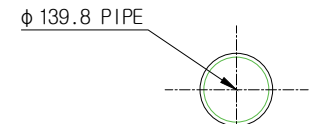

PIPE POST 상세도