

2W 표준 노측용 SB2 (성토부 JISG-2W-RS-02)

완충브라켓 상세도

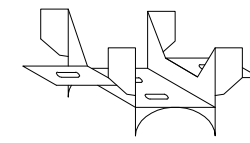

사시도

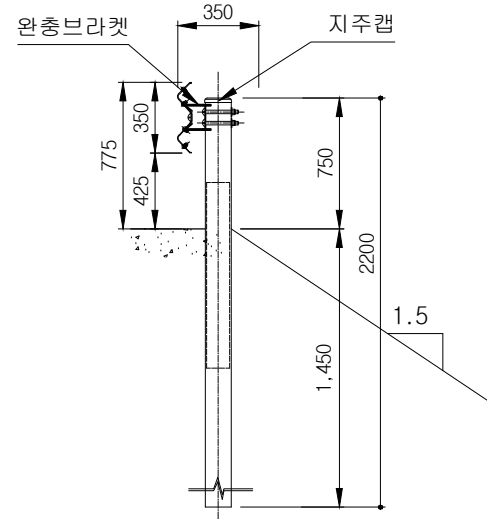
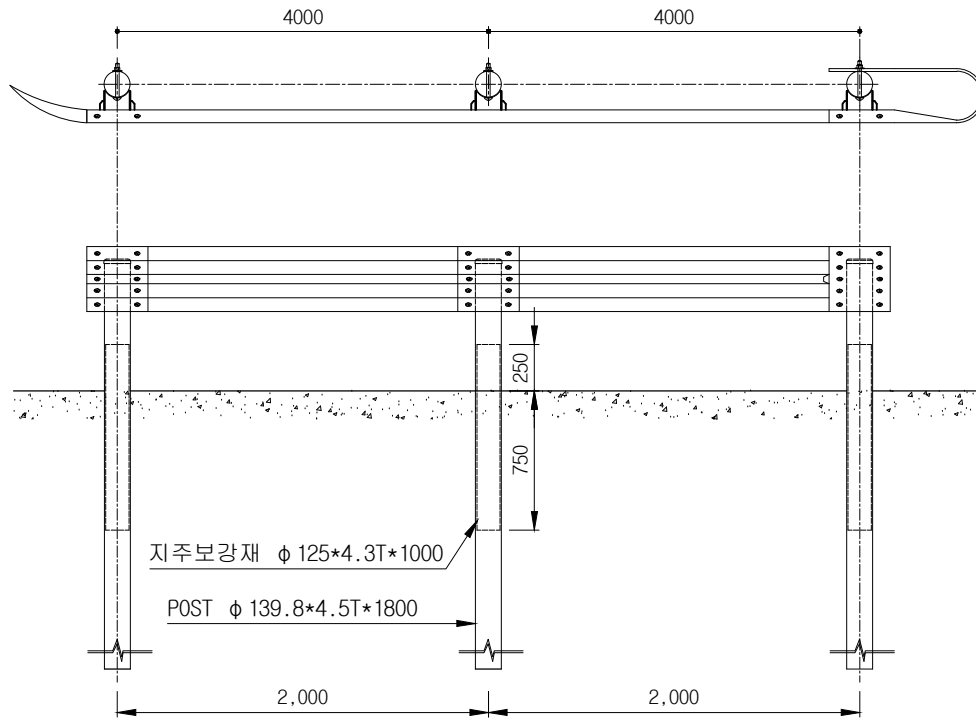
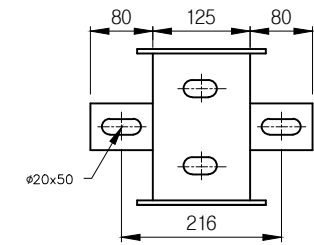

정면도

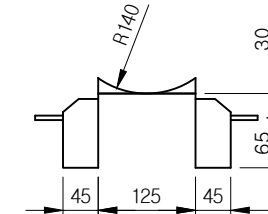

평면도

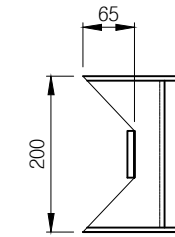

측면도

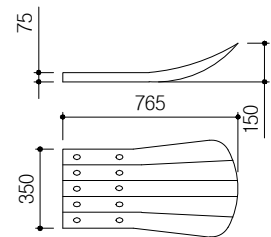
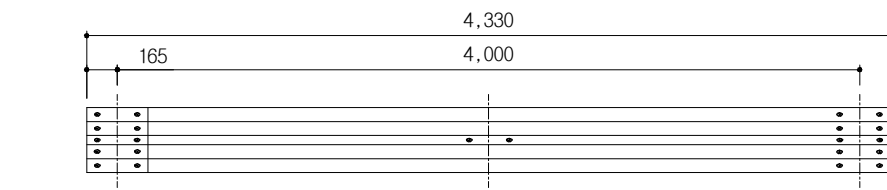
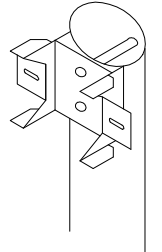

단부레일 상세도

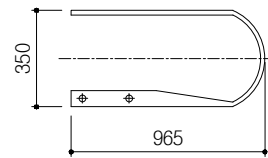

지주캡 상세도

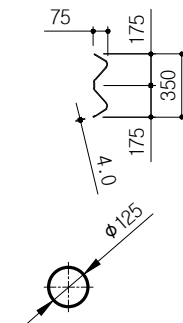

지주보강재

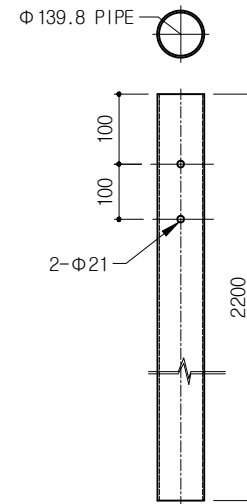

PIPE POST 상세도

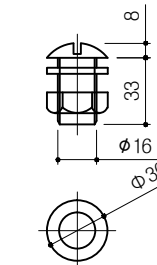

JOINTING B/N ($\phi 16 \times 33$)

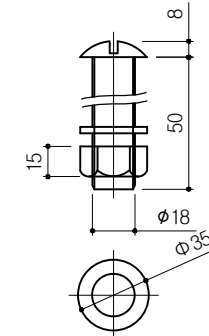

SETTING B/N ($\phi 18 \times 50$)

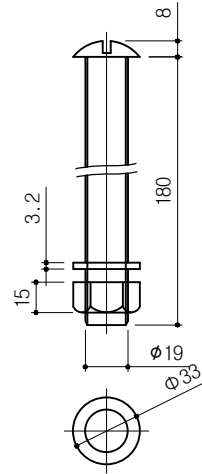

SETTING B/N ($\phi 19 \times 180$)

자재리스트

1경간(4M)당 재료표

No.	품목	규격	단위	수량	재질	방식처리
1	GUARD RAIL	4.0T*350*4,330	매	1	SS400	용융아연도금 및 분체도장 선택사용
2	PIPE POST	$\phi 139.8 \times 4.5T \times 2,200$	본	1	STK400	
3	지주 CAP	$\phi 139.8$ 용	EA	1	SPHC	
4	완충브라켓	3.2T*125*95	EA	1	SS400	
5	SETTING B/N	$\phi 19 \times 180$	EA	2	SS400	
6	JOINTING B/N	$\phi 16 \times 33$	EA	8	SS400	
7	SETTING B/N	$\phi 18 \times 50$	EA	2	SS400	
8	지주보강재	$\phi 125 \times 4.3T \times 1000$	본	1	STK400	

(주)제일산업외

도로 안전 부대시설 표준도

REV. No.

최종작성일

2017. 09.

도면
제목

2W 표준 노측용 SB2
(성토부 JISG-2W-RS-02)

도면
번호